

Operating instructions

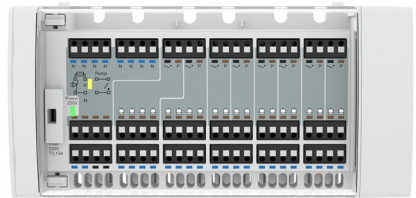

Basic controller terminal bar (wired)

Product family CosiTherm®

Type: WB 10 D8-230



Copyright 2023 AFRISO-EURO-INDEX GmbH. All rights reserved.



Lindenstraße 20
 74363 Güglingen
 Telephone +49 7135 102-0
 Service +49 7135 102-211
 Telefax +49 7135 102-147
 info@afriso.com
 www.afriso.com

1 About these operating instructions

These operating instructions describe the (basic) controller terminal bar WB 10 D8-230 (also referred to as "product" in these operating instructions). These operating instructions are part of the product.

- You may only use the product if you have fully read and understood these operating instructions.
- Verify that these operating instructions are always accessible for any type of work performed on or with the product.
- Pass these operating instructions as well as all other product-related documents on to all owners of the product.
- If you feel that these operating instructions contain errors, inconsistencies, ambiguities or other issues, contact the manufacturer prior to using the product.

These operating instructions are protected by copyright and may only be used as provided for by the corresponding copyright legislation. We reserve the right to modifications.

The manufacturer shall not be liable in any form whatsoever for direct or consequential damage resulting from failure to observe these operating instructions or from failure to comply with directives, regulations and standards and any other statutory requirements applicable at the installation site of the product.

2 Information on safety

2.1 Safety messages and hazard categories

These operating instructions contain safety messages to alert you to potential hazards and risks. In addition to the instructions provided in these operating instructions, you must comply with all directives, standards and safety regulations applicable at the installation site of the product. Verify that you are familiar with all directives, standards and safety regulations and ensure compliance with them prior to using the product.

Safety messages in these operating instructions are highlighted with warning symbols and warning words. Depending on the severity of a hazard, the safety messages are classified according to different hazard categories.



DANGER

DANGER indicates a hazardous situation, which, if not avoided, will result in death or serious injury.

NOTICE

NOTICE indicates a hazardous situation, which, if not avoided, can result in equipment damage.

In addition, the following symbols are used in these operating instructions:



This is the general safety alert symbol. It alerts to injury hazards or equipment damage. Comply with all safety instructions in conjunction with this symbol to help avoid possible death, injury or equipment damage.



This symbol alerts to hazardous electrical voltage. If this symbol is used in a safety message, there is a hazard of electric shock.

2.2 Intended use

This product may only be used for wiring the room thermostats and the thermostatic actuators. The product supplies the actuators and room thermostats.

Any use other than the application explicitly permitted in these operating instructions is not permitted and causes hazards.

Verify that the product is suitable for the application planned by you prior to using the product. In doing so, take into account at least the following:

- All directives, standards and safety regulations applicable at the installation site of the product
- All conditions and data specified for the product
- The conditions of the planned application

In addition, perform a risk assessment in view of the planned application, according to an approved risk assessment method, and implement the appropriate safety measures, based on the results of the risk assessment. Take into account the consequences of installing or integrating the product into a system or a plant.

When using the product, perform all work and all other activities in conjunction with the product in compliance with the conditions specified in the operating instructions and on the nameplate, as well as with all directives, standards and safety regulations applicable at the installation site of the product.

2.3 Predictable incorrect application

The product must never be used in the following cases and for the following purposes:

- Hazardous area
 - If the product is operated in hazardous areas, sparks may cause deflagrations, fires or explosions.
- In conjunction with products which are used for health-saving or life-saving purposes or whose operation may incur hazards to humans, animals or property.

2.4 Qualification of personnel

Only skilled, qualified persons with relevant education and experience to enable him or her to perceive risks and to avoid hazards which electricity can create are authorised to mount, commission, maintain and decommission this product.

Only appropriately trained persons who are familiar with and understand the contents of these operating instructions and all other pertinent product documentation are authorized to work on and with this product.

These persons must have sufficient technical training, knowledge and experience and be able to foresee and detect potential hazards that may be caused by using the product.

All persons working on and with the product must be fully familiar with all directives, standards and safety regulations that must be observed for performing such work.

2.5 Personal protective equipment

Always wear the required personal protective equipment. When performing work on and with the product, take into account that hazards may be present at the installation site which do not directly result from the product itself.

2.6 Modifications to the product

Only perform work on and with the product which is explicitly described in these operating instructions. Do not make any modifications to the product which are not described in these operating instructions.

3 Transport and storage

The product may be damaged as a result of improper transport or storage.

NOTICE

INCORRECT HANDLING

- Verify compliance with the specified ambient conditions during transport or storage of the product.
- Use the original packaging when transporting the product.
- Store the product in a clean and dry environment.
- Verify that the product is protected against shocks and impact during transport and storage.

Failure to follow these instructions can result in equipment damage.

4 Product description

4.1 Overview

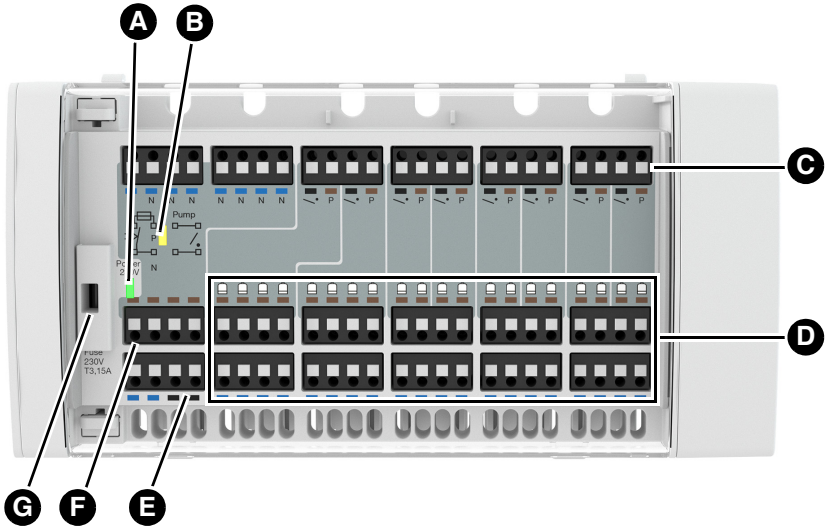

- A. Operation supply voltage (LED green)
- B. Pump active (LED yellow)
- C. Terminal block for room thermostats
- D. Terminal block for thermostatic actuators
- E. Connection terminals for pump
- F. Supply voltage AC 230 V
- G. Fuse compartment mains fuse

4.2 Dimensions

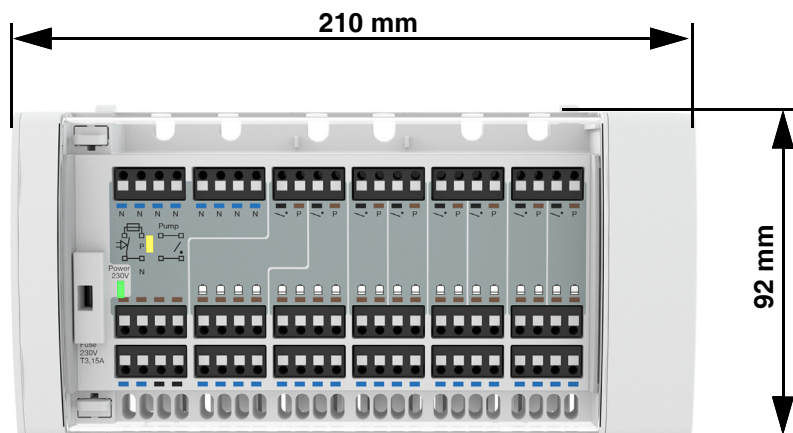

Fig. 1: Dimensions product

4.3 Function

CosiTherm® is a single room temperature controller used to control the temperature in rooms with underfloor heating system. The product is a part of CosiTherm®.

The product with 8 independent control circuits supplies the room thermostats and the thermostatic actuators. The room thermostat switches the thermostatic actuator via the product to control the heating circuit at the manifold.

The control circuit pumps can be controlled via the product. When all heating circuits are closed, the pump is switched off.

4.4 Application example

Up to 8 room thermostats and 20 actuators can be connected to the product.

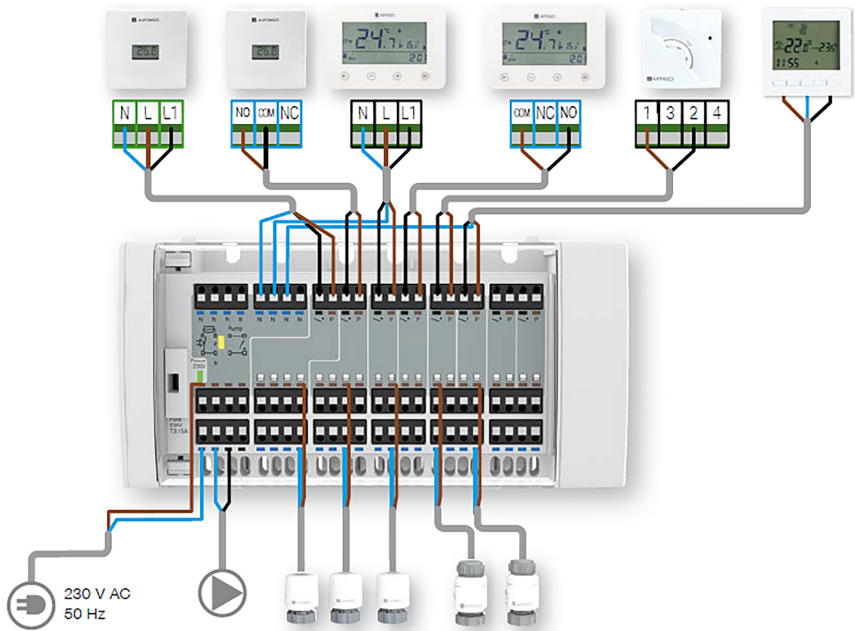

Fig. 2: Controller terminal bar with room thermostats, pump and thermostatic actuators

4.5 Approvals, conformities, certifications

The product complies with:

- EMC Directive (2014/30/EU)
- Low Voltage Directive (2014/35/EU)
- RoHS Directive (2011/65/EU)

4.6 Technical specifications

Parameter	Value
General specifications	
Dimensions housing (W x H x D)	210 x 92 x 24 mm
Weight	275 g
Housing material	PC/ABS
The following components may be connected to one product	
Room thermostats	8
Thermostatic actuators	20
Ambient conditions	
Ambient temperature operation	5 ... 50 °C
Ambient temperature storage	-25 ... 60 °C
Relative humidity	< 70 % non-condensing
Electrical data	
Supply voltage	AC 230 V, 50 ... 60 Hz
Power input at no load	< 1 W
Maximum power input (without pump)	34 VA
Mains fuse	T 3.15 A
Permissible cable type to thermostatic actuators	H05 VV-H2-F 2 x 0.75 mm ²
Permissible cable type to room thermostats	Depends on room thermostat
Protection class (EN 60730)	II
Degree of protection (EN 60529)	IP 20
Pollution degree (EN 60730)	2
Rated impulse voltage (EN 60730)	2500 V
Type (EN 60730)	2 (service life 100,000 switchings of pump)

5 Mounting

5.1 Electrical connection



DANGER

ELECTRIC SHOCK

- Verify that the degree of protection against electric shock (protection class, double insulation) is not reduced by the type of electrical installation.

Failure to follow these instructions will result in death or serious injury.



DANGER

ELECTRIC SHOCK CAUSED BY LIVE PARTS

- Disconnect the supply voltage before performing the work and ensure that it cannot be switched on.
- Verify that no hazards can be caused by electrically conductive objects or media.

Failure to follow these instructions will result in death or serious injury.

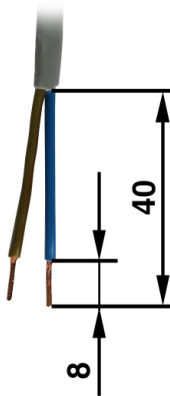

- ⇒ Verify that a connection concept has been created.
 - ⇒ Verify that all cables are disconnected from power.
1. Strip the cables as shown.

Fig. 3: Stripping the cables

5.1.1 Connecting a thermostatic actuator

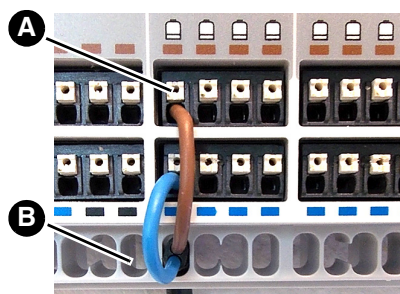

1. Route the cables of the thermostatic actuator through the strain relief (B).
2. Connect the wires (observe colour coding).
3. Push the stripped wires into the terminals all the way to the stop.
4. Push the catch (A) to disconnect the wires.

Fig. 4: Connecting a thermostatic actuator

5.1.2 Connecting a room thermostat

⇒ Refer to the operating instructions of the room thermostat for information on the wires to connect.

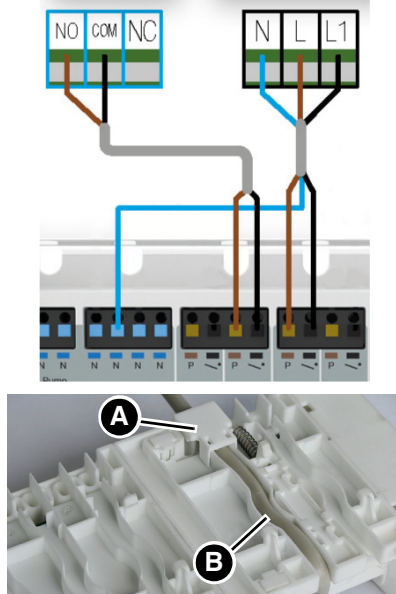

1. Connect the wires of the room thermostat (observe colour coding).
2. Push the stripped wires into the terminals all the way to the stop.
3. Route the cable through the cable guide (B) at the rear of the product.
4. Fix the cable of the room thermostat and the cable of the thermostatic actuator with the cable clamp (A).
5. Repeat this procedure for all other cables.
6. Push the catch to disconnect the wires.

Fig. 5: Connecting a room thermostat

5.1.3 Fitting the cable clamp

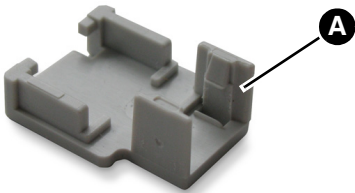

1. Fix the cable at the rear of the product using the cable clamp (B). Connect the room thermostat before fitting the cable clamp.

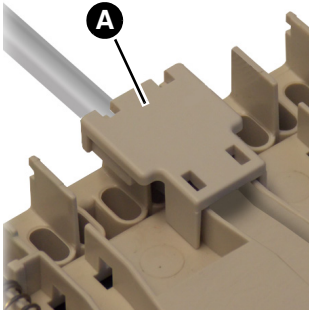
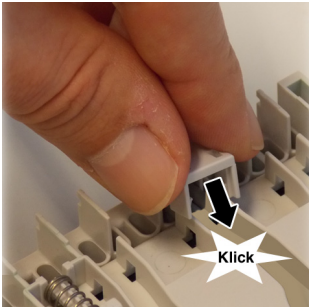
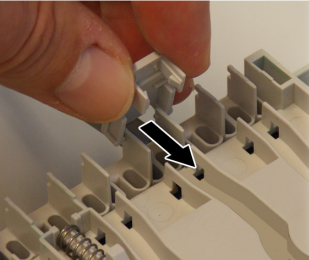

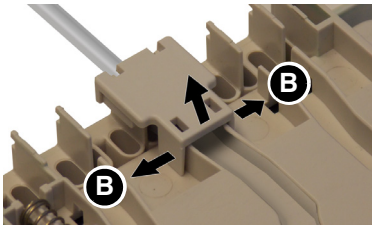

2. Repeat this procedure for all other cables.
3. It is possible to open the cable clamps. To do so, pull the two tabs (B) outwards and remove the cable clamp.

5.1.4 Connecting the pump Via the supply voltage of the product

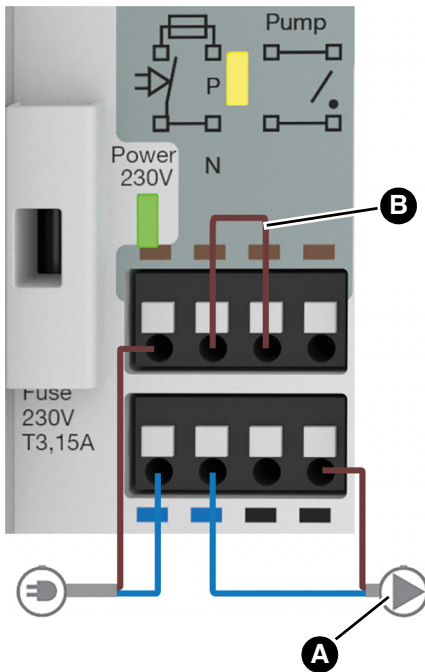

1. Route the cable of the pump (A) through the strain relief.
2. Connect the wires (observe colour coding).
3. Connect the wiring bridge (B) to the terminals of the supply voltage and the pump controller.
4. Push the catch to disconnect the wires.

Fig. 6: Connecting the pump via the supply voltage of the product

Via the voltage-free output of the product

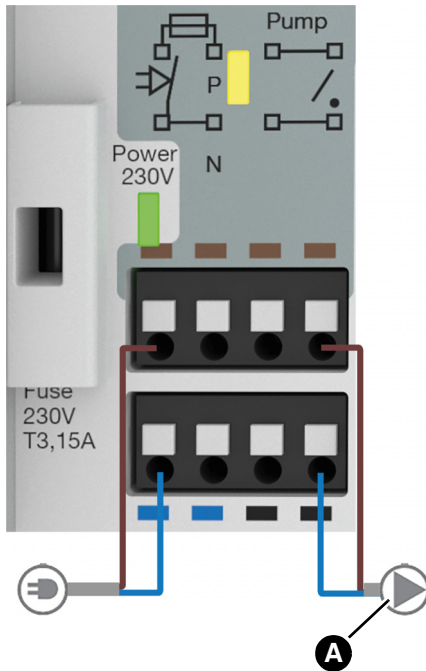

1. Route the cable of the pump (A) through the strain relief.
2. Connect the wires as shown in the illustration.
3. Push the catch to disconnect the wires.

Fig. 7: Connecting the pump via the voltage-free output of the product

5.2 Mounting the product on a DIN rail

⇒ Verify that all cables are connected.



1. Fit the product into the DIN rail with the upper hooks.
2. Push the lower end of the product towards the DIN rail until it snaps in with a click.

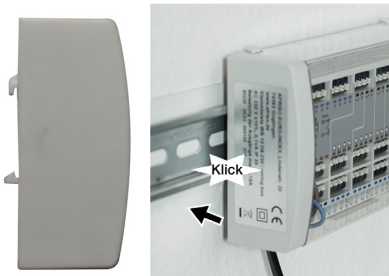
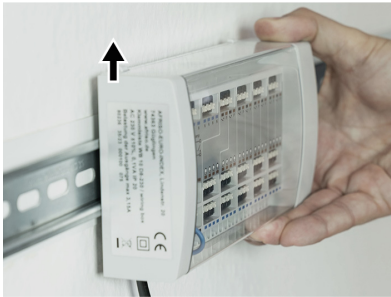
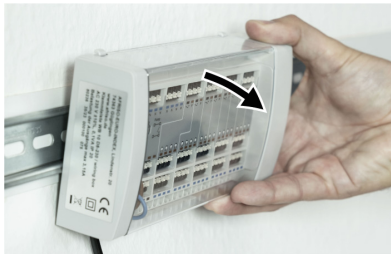

Fig. 8: Mounting the product on a DIN rail

5.3 Removing the product from the DIN rail



1. Slightly lift the product.



2. Tilt the top of the product away from the DIN rail.

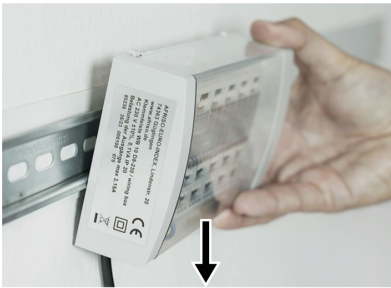

3. Remove the product towards the bottom.

Fig. 9: Removing the product from the DIN rail

6 Commissioning

6.1 Commissioning the product

- ⇒ Verify that the product has been properly mounted and electrically connected.
- ⇒ Verify that the product is properly mounted to the DIN rail.
- ⇒ Switch on the supply voltage.
 - The green LED for the product lights.

6.2 Performing the function test

Room thermostat

- ⇒ Verify that the room temperature is between 15 °C and 25 °C.
1. Verify that the room thermostat to be tested is connected to the correct control circuit.
 2. Set the room thermostat to be tested to 30 °C.
 - The thermostatic actuator opens the control circuit.
 3. Repeat this procedure for all other room thermostats.

7 Operation

7.1 Overview of the LED signals

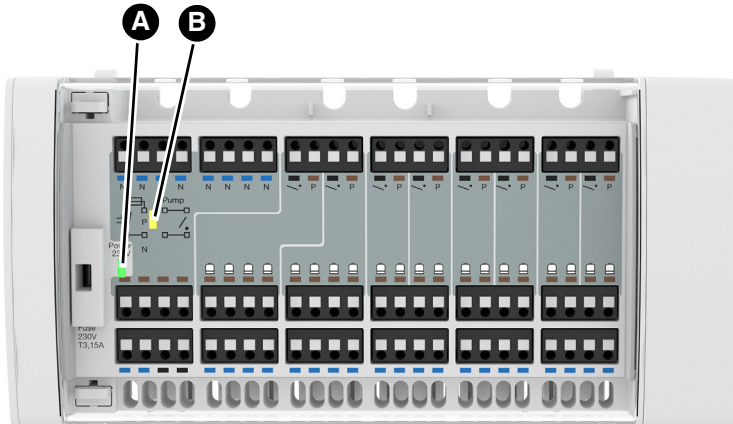

Fig. 10: Overview of the LED signals

	Indication	State	Explanation
A.	Operation AC 230 V (LED green)	Solid lit	When supply voltage for the thermostatic actuators and the room thermostats is applied
		Goes off	In the case of power outage If the fuse trips
B.	Pump (LED yellow)	Solid lit	If at least one room thermostat is requesting heating energy
		Goes off	If no room thermostat is requesting heating energy

8 Maintenance

The product is maintenance-free.

9 Troubleshooting

Any malfunctions that cannot be removed by means of the measures described in this chapter may only be repaired by the manufacturer.

Problem	Possible reason	Repair
LED AC 230 V operation not lit (green LED)	No supply voltage	Check the power supply
	Fuse tripped	Check the fuse
Other malfunctions	-	Contact the AFRISO service hotline

9.1 Replacing the fuse

⇒ Verify that the supply voltage is interrupted and cannot be switched on.



1. Open the cover using a screwdriver.



2. Remove the fuse holder.

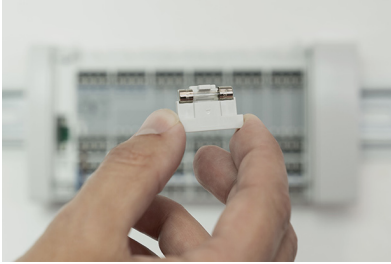

3. Replace the defective fuse with a fuse of the same type.



4. Insert the fuse holder into the fuse compartment.
5. Close the cover.

10 Decommissioning, disposal

Dispose of the product in compliance with all applicable directives, standards and safety regulations.

Electronic components must not be disposed of together with the normal household waste.



1. Disconnect the product from mains.
2. Dismount the product (see chapter "Electrical connection", reverse sequence of steps).
3. Dispose of the product.

11 Returning the device

Get in touch with us before returning your product (service@afriSO.de).

12 Warranty



See our terms and conditions at www.afriSO.com or your purchase contract for information on warranty.

13 Spare parts and accessories

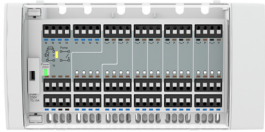
Product

Product designation	Part no.	Figure
CosiTherm® Basic controller terminal bar WB 10 D8-230	80236	

Spare parts and accessories

Product designation	Part no.	Figure
Room thermostat RT 10 D-230	86062	
Thermostatic actuator TSA-02	78882	
Thermostatic actuator TSA 02 FO	79016	

14 Appendix

14.1 EU Declaration of Conformity

		
Technik für Umweltschutz Messen, Regeln, Überwachen.		
EU - Konformitätserklärung <i>EU Declaration of Conformity / Déclaration EU de conformité / Declaración de conformidad CE / Declaração de conformidade CE / Deklaracja zgodności UE</i>	 <div style="display: inline-block; text-align: left; font-size: small;"> Formblatt FB 27 - 03 </div>	
<p>Name und Anschrift des Herstellers: <u>AFRISO-EURO-INDEX GmbH, Lindenstraße 20, 74363 Güglingen</u> <i>Manufacturer / Fabricant / Fabricante / Nome e endereço do fabricante / Product:</i></p> <p>Erzeugnis: <u>Einzelraum-Temperaturregelung CosiTherm Basic Klemmleiste</u> <i>Product / Produkt / Producto / Produto / Produkt:</i></p> <p>Typenbezeichnung: <u>WB 10 D8-230</u> <i>Type / Type / Tipo / Tipo / Typ:</i></p> <p>Betriebsdaten: <u>AC 230 V, 3,15 A, IP 20</u> <i>Techn. Details / Caractéristiques / Características / Detalles técnicos / Dane techniczne:</i></p> <p>Wir erklären in alleiniger Verantwortung, dass das bezeichnete Erzeugnis mit den Vorschriften folgender Europäischer Richtlinien übereinstimmt: <i>We declare under our sole responsibility that the above mentioned product meets the requirements of the following European Directives:</i> <i>Le produit mentionné est conforme aux prescriptions des Directives Européennes suivantes:</i> <i>El producto indicado cumple con las prescripciones de las Directivas Europeas siguientes:</i> <i>O produto indicado cumpre com as prescrições das seguintes Diretivas Europeias:</i> <i>Wymieniony wyżej produkt spełnia wymagania następujących Dyrektyw Europejskich:</i></p> <p>Elektromagnetische Verträglichkeit (2014/30/EU) <i>Directive Electromagnetic Compatibility / Directive compatibilité électromagnétique / Directiva compatibilidad electromagnética / Directiva sobre compatibilidade eletromagnética / Dyrektywa kompatybilności elektromagnetycznej</i></p> <p><u>EN 60730-1:2011; EN 60730-2-9:2010</u> <i>(erfüllt auch / meets also EN 60730-1:2016 + A1 2019; EN 60730-2-9:2015+A1:2018+A2:2020)</i></p> <p>Niederspannungsrichtlinie (2014/35/EU) <i>Low Voltage Directive / Directive basse tension / Directiva baja tensión / Directiva sobre baixa tensão / Dyrektywa niskonapięciowa</i></p> <p><u>EN 60730-1:2011; EN 60730-2-9:2010</u> <i>(erfüllt auch / meets also EN 60730-1:2016 + A1 2019; EN 60730-2-9:2015+A1:2018+A2:2020)</i></p> <p>RoHS-Richtlinie (2011/65/EU) <i>RoHS Directive / Directive RoHS / Directiva RoHS / Directiva RoHS / Dyrektywa RoHS</i></p> <p><u>EN IEC 63000:2018</u></p> <p>Unterzeichner: <u>Dr. Späth, Geschäftsführer Technik</u> <i>Signed / Signataire / Firmante / Assinado por / Podpisat:</i> <i>Technical Director / Diretor Técnico / Dyrektor Techniczny</i></p> <p style="text-align: center;"> <u>10. Juli 2023</u> <i>Datum / Date / Fecha / Data</i> </p> <div style="text-align: right; margin-top: 10px;">  <div style="font-size: x-small; margin-left: 20px;"> AFRISO-EURO-INDEX GmbH Lindenstraße 20 • 74363 Güglingen Tel. +49 7143 102-0 • www.afriso.de </div> </div>		
Version: 3 Index: 5	AFRISO-EURO-INDEX GmbH D-74363 Güglingen	Seite 1 von 1

69020 55004 0013